

MODULAR DEVICES FOR RESIDUAL CURRENT PROTECTION

RCBO - MDC

Technical data

TYPE		MDC 45		MDC 60		MDC 100		MDC 100 MA			
Standard		EN 61009-1		EN 61009-1		EN 61009-1		EN 61009-1			
Rated current (In)	(A)	6-32		6-32		6-32		6-32			
Utilization category		A		A		A		A			
Rated operational voltage (Ue)	(V AC)	230 / 400		230 / 400		230		110			
Insulation voltage (Ui)	(V)	500		500		500		500			
Rated frequency	(Hz)	50		50		50		50			
Rated impulse withstand voltage (Uimp)		4		4		4		4			
Overvoltage category		III		III		III		III			
Number of poles		1+N, 2	3, 4	1+N, 2	3, 4	1+N, 2, 3			2		
BREAKING CAPACITY	Alternating current IEC 61009 - EN 61009		(A)								
		Icn	4500		6000		10000		10000		
		Ics	1 Icn		1 Icn		0.75 Icn		0.75 Icn		
	Alternating current IEC 60947-2 - EN 60947-2 (kA)		Ue (V)								
		Icu	230	6	-	7.5	-	10		10	
		400	-	4,5	-	6	-		-		
	Ics		100% Icu		100% Icu		75% Icu		75% Icu		
Rated residual operating current (IΔn)		(mA)									
Type	AC		30		30		30		30		
			300		300		300		300		
	A		30		30		30		30		
			-		-		100		-		
			300		300		300		300		
	A[IR]	-		30		30		-			
	A[S]	-		300		-		-			
Level of immunity (8/20 μs)		(A)		250		250 (for AC and A types) 3000 (for A[IR] and A[S] types)		250 (for AC and A types) 3000 (for A[IR] type)		250	
Residual making and breaking capacity (IΔm)		(A)		Icn circuit breaker		4500		4500		4500	
Wiring	cable section (mm²)	rigid	≤ 1x35 - ≤ 2x16 - ≤ 1x16+2x10		≤ 1x35 - ≤ 2x16 - ≤ 1x16+2x10		≤ 1x35 - ≤ 2x16 - ≤ 1x16+2x10		≤ 1x35 - ≤ 2x16 - ≤ 1x16+2x10		
		flexible	≤ 1x35 - ≤ 2x16 - ≤ 1x16+2x10		≤ 1x35 - ≤ 2x16 - ≤ 1x16+2x10		≤ 1x35 - ≤ 2x16 - ≤ 1x16+2x10		≤ 1x35 - ≤ 2x16 - ≤ 1x16+2x10		
Electrical endurance				10000		10000		10000		10000	
Mechanical endurance				20000		20000		20000		20000	
Max. no. of usable modular accessories:				2		2		2		2	
Upline/Downline power supply				yes		yes		yes		yes	
Status displayed				yes		yes		yes		yes	
Rated tightening torque		(Nm)		2		2		2		2	
Screwdriver suggested				PZ2		PZ2		PZ2		PZ2	
Degree of protection	terminals			IP20		IP20		IP20		IP20	
	front			IP40		IP40		IP40		IP40	
Tropicalization				55°C - RH 95%		55°C - RH 95%		55°C - RH 95%		55°C - RH 95%	
Reference temperature		(°C)		30		30		30		30	
Operating temperature		(°C)		-25 +40		-25 +40		-25 +40		-25 +40	
Stocking temperature		(°C)		-40 +70		-40 +70		-40 +70		-40 +70	
Weight per pole		(g)		120		120		120		120	
Tripping characteristic				C		C B		C B		C	
Rated currents available (In)	(A)		6		6		6		6		
			10		10		10		10		
			13		13		13		13		
			16		16		16		16		
			20		20		20		20		
			25		25		25		25		
			32		32		32		32		

MODULAR DEVICES FOR RESIDUAL CURRENT PROTECTION

ADD-ON RCD - BD - BDHP

Technical data

TIPO		BD		BDHP	BDHP ADJUSTABLE	
Standard		EN 61009-1 app. G		EN 61009-1 app. G	EN 60947-2 app. B	
Rated current (I _n)	(A)	≤ 25	≤ 63	≤ 125	≤ 125	
Rated operational voltage (U _e)	(V AC)	230/400		230/400	230/400	
Insulation voltage (U _i)	(V)	500		500	500	
Rated frequency	(Hz)	50		50	50	
Rated impulse withstand voltage (U _{imp})	(kV)	4		4	4	
Overvoltage category		III		III	III	
Number of poles		2,3,4		2,3,4	4	
Rated residual operating current (I _{Δn})	(mA)					
Type	AC	10 ⁽¹⁾	-	-	-	
		30	30	30	-	
		300	300	300	-	
		500	500	-	-	
	A	30	30	30	-	
		300	300	300	-	
		500	500	-	-	
	A[IR]	-	30	-	-	
	A[S]	-	300	300	-	
		-	1000	1000	-	
A[Adj.]	-	-	-	300 - 500 - 1000 - 3000		
Adjustable tripping time (t)	(ms)	-		-	0 - 60 - 150	
Level of immunity (8/20 μs)	(A)	250 (for AC and A types) 3000 (for A[IR] and A[S] types)		250 (for AC and A types) 3000 (for A[S] types)	3000	
Residual making and breaking capacity (I _{Δm})	(A)	I _{cn} circuit breaker		I _{cn} circuit breaker	I _{cn} circuit breaker	
Wiring	cable section (mm ²)	rigid	≤ 1x35 - ≤ 2x16 - ≤ 1x16+2x10		≤ 1x70 - ≤ 2x25 - ≤ 2x25+1x10	≤ 1x70 - ≤ 2x25 - ≤ 2x25+ 1x10
		flexible	≤ 1x35 - ≤ 2x16 - ≤ 1x16+2x10		≤ 1x50 - ≤ 2x25 - ≤ 3x16	≤ 1x50 - ≤ 2x25 - ≤ 3x16
Upline/Downline power supply		yes		yes	yes	
Rated tightening torque	(Nm)	2		3,5 / 3 (terminals)	3,5 / 3 (terminals)	
Screwdriver suggested		PZ2		PZ2	PZ2	
Degree of protection	terminals	IP20		IP20	IP20	
	front	IP40		IP40	IP40	
Tropicalization		55°C - RH 95%		55°C - RH 95%	55°C - RH 95%	
Reference temperature	(°C)	30		30	30	
Operating temperature	(°C)	-25 +40		-25 +40	-25 +40	
Stocking temperature:	(°C)	-40 +70		-40 +70	-40 +70	
Weight per pole	(g)	100		200	200	

⁽¹⁾ Only for 2P versions

MODULAR DEVICES FOR RESIDUAL CURRENT PROTECTION

RCCB - IDP

Technical data

	IDP NA	IDP	IDP 4P (3M)	IDP 125A	IDP B Type		
Standard	EN 61008-1 / IEC 61008-1 / EN 61008-2-1 / IEC 61008-2-1				EN 62423		
Rated current (In) (A)	25-40-63	25-100	25-40	125	25-80		
Rated operational voltage (Ue) (V a.c.)	230/400	230/400	230/400	400	230/400		
Insulation voltage (Ui) (V)	500	500	500	500	500		
Rated impulse withstand voltage (Uimp) (kV)	4	4	4	4	4		
Rated frequency (Hz)	50	50/60*	50	50	50 / 60		
Poles	2 (Up to 40A) 4 (Up to 63A)	2, 4	4	4	2 (Up to 40A) 4 (Up to 80A)		
Number of modules	2 (2P) 4 (4P)	2 (2P) 4 (4P)	3	4	4 (2P / 4P)		
Rated residual operating current (IΔn) (mA)							
Type	AC	-	10 ⁽¹⁾	-	-		
		30	30	30	30		
		-	100	100	-		
		300	300	300	300		
		-	500	500	500		
		-	10 ⁽¹⁾	10 ⁽¹⁾	-		
	A	30	30	30	30		
		-	100	100	-		
		300	300	300	300		
		-	500	500	500		
		-	30	-	-		
		-	300	-	-		
IR - Impulse resistant	-	-	-	-			
	-	300	-	-			
S - Selective	-	-	-	-			
	-	300	-	-			
Level of immunity (8/20μs) (A)	250	250 AC - A 3000 A[I _R] - A[S]	250	250	3000 (Type B[I _R]) 5000 (Type B[S])		
Residual making and breaking capacity (I_{dm}) (A)	10 x In (500A min)	10xIn (500A min)	630	1250	800		
Making and breaking capacity (I_m) (A)	10 x In (500A min)	10xIn (500A min)	630	1250	800		
Voltage independent	YES	YES	YES	YES	YES		
Wiring	Cable section (mm²)	rigid	≤35	≤35	≤35	≤50	≤25
		flexible	≤35	≤35	≤25	≤50	≤25
Electrical endurance	≥5000	≥10000	≥5000	≥10000	≥10000		
Mechanical endurance	≥10000	≥20000	≥10000	≥10000	≥10000		
Upstream / Downstream supply	YES	YES	YES	YES	YES		
Rated tightening torque (Nm)	2	3	2	3	2,5		
Screw type	PZ2	PZ2	PZ2	PZ2	PZ2		
Pollution degree	2	2	2	2	2		
Fire resistance	Glow wire Test IEC 60695-2-11 according with IEC 61008-1	Glow wire Test IEC 60695-2-11 according with IEC 61008-1	Glow wire Test IEC 60695-2-11 according with IEC 61008-1	Glow wire Test IEC 60695-2-11 according with IEC 61008-1	Glow wire Test IEC 60695-2-11 according with IEC 61008-1		
IP degree (inside the distribution board)	IP40	IP40	IP40	IP40	IP40		
Tropicalization	55°C 95% Hr (EN 60068-2-60)	55°C 95% Hr (EN 60068-2-60)	55°C 95% Hr (EN 60068-2-60)	55°C 95% Hr (EN 60068-2-60)	55°C 95% Hr (EN 60068-2-60)		
Installation altitude (m)	≤2000	≤2000	≤2000	≤2000	≤2000		
Operating temperature (average daily temperature ≤35°C) (°C)	-5 ÷ +40	-25 ÷ +60	-25 ÷ +40	-25 ÷ +40	-25 ÷ +45		
Storage temperature (average daily temperature ≤35°C) (°C)	-40 ÷ +70	-40 ÷ +70	-40 ÷ +70	-40 ÷ +70	-40 ÷ +70		
Double connection (cable + fork busbar)	NO (for 2P) YES (only downstream for 4P)	YES (Upstream and downstream)	YES (Upstream and downstream)	NO	YES (only downstream)		
Signalization of the relay tripping	NO	YES	NO	NO	NO		

⁽¹⁾ Up to 25A

*60Hz IDP: available upon request

RATED CONDITIONAL RESIDUAL SHORT-CIRCUIT CURRENT IΔc (kA)												
Rated current In	25A / 40A (NA)		25A / 40A			63A (NA)	63A	80A		100A		125A
	Poles	2P	4P	2P	4P	4P (3M)	2P/4P	2P/4P	2P	4P	2P	4P
Fuse	gG 63A	6	6	10	10	6	6	-	-	-	-	-
	gG 80A	-	-	-	-	-	-	10	-	-	-	-
	gG 100	-	-	10*	10*	-	-	10*	10	10	10	10
	gG 125	-	-	-	-	-	-	-	-	-	-	10
MCB	MTC 45	-	-	4,5	-	-	-	-	-	-	-	-
	MTC 60	-	-	6	-	-	-	-	-	-	-	-
	MT 60	-	-	6	-	-	6	-	-	-	-	-
	MT 100	-	-	10	-	-	10	-	-	-	-	-
	MT 250	-	-	10	-	-	10	-	-	-	-	-
	MTHP 160	-	-	-	-	-	10	-	10	-	10	10
	MTHP 250	-	-	10	-	-	10	-	-	-	-	-

* Only Type B RCCBs

For technical information contact the Technical Assistance Service or visit [gewiss.com](http://www.gewiss.com)

Power loss values and temperature performance

MDC 45 - 60 - 100 compact residual current circuit breakers with overcurrent protection

Technical characteristics

For circuit overcurrent protection and the residual current protection of devices and services, there are the MDC 45, MDC 60 and MDC 100 compact residual current circuit breakers with overcurrent protection.

The MDC compact miniature circuit breakers with residual current release have a thermomagnetic part with the same characteristics as the MTC circuit breakers. The residual current release - assembled in the factory inside the same modular shell - is available in AC, A, A[IR] impulse resistant and A[S] selective versions with a rated residual current of 30, 100 and 300 mA.

Some advice about selection and installation

One of the most common problems when installing residual current circuit breakers is the untimely tripping caused by earth leakage which is not due to real faults.

The most frequent causes are:

- services with electronic devices such as computers, hi-fi systems and household appliances in general, which are fitted with anti-interference capacity filters
- capacity effects of the electrical lines of the system which have a high capacity towards earth, especially if they are widely extended.

In these cases, the capacity effect leads to the generation of a residual current leakage, causing the circuit breaker to trip. The intensity of this current increases above all when there are surges of voltage in the mains due to atmospheric disturbance, or transitory interference caused by the services. At the time of switch-off, fluorescent lamps equipped with a ballast are typical generators of such interference, which can be removed by introducing small capacities in parallel. All residual current circuit breakers are equipped with anti-interference devices.

In the presence of electronic equipment which can generate one-way runaway currents, it is essential to install A-type residual current circuit breakers.

MDC temperature performance

In (A)	Temperature					
	10°C	20°C	30°C	40°C	50°C	60°C
6	7.2	6.6	6	5.7	5.3	5
10	11.8	10.8	10	9.6	9.1	8.6
13	14.8	14	13	12.2	11.2	10.3
16	18.2	17.2	16	15.2	14.3	13.4
20	22.8	21.4	20	19.5	18.9	18.4
25	28.5	26.8	25	24	23	22
32	36.5	34.2	32	30.8	29.5	28.8

MDC power loss per pole

In (A)	6		10		13		16		20		25		32	
	Pole	N	Pole	N	Pole	N	Pole	N	Pole	N	Pole	N	Pole	N
R (mΩ)	29.4	2.6	20.6	2.6	14.5	2.6	8.9	2.6	6.8	2.6	4.6	2.6	3.6	2.6
P (W)	1.06	0.09	2.06	0.26	2.45	0.44	2.28	0.67	2.72	1.04	2.88	2	3.67	2.66

BD - BDHP add-on for miniature circuit breaker

Add-on for MT (BD) and MTHP (BDHP) miniature circuit breakers, which can be coupled by the installer once only (in compliance with Standard CEI EN 61009, appendix G). AC, A, A[IR] impulse resistant, A[S] selective and adjustable types are available.

BD and BDHP power loss per pole

Power loss (W)		Rated current of the associated MT/MTHP miniature circuit breaker [A]																
		1	2	3	4	6	10	13	16	20	25	32	40	50	63	80	100	125
BD add-on	2P	0.01	0.04	0.01	0.02	0.04	0.11	0.2	0.29	0.45	0.70	0.45	0.70	1.10	1.75	-	-	-
	3P-4P	0.002	0.008	0.02	0.03	0.07	0.21	0.37	0.53	0.83	1.30	0.65	1.00	1.60	2.50	-	-	-
BDHP add-on		-	-	-	-	-	-	-	-	0.2	0.3	0.5	0.8	1.25	2	1.4	2.2	3.4

MODULAR DEVICES FOR RESIDUAL CURRENT PROTECTION

IDP residual current circuit breakers

TECHNICAL CHARACTERISTICS

Two-pole and four-pole residual current circuit breakers without built-in overcurrent releases - free release monobloc.

AC class devices with instantaneous tripping are available (for residual sinusoidal alternating currents only), whereas A class residual current circuit breakers (suitable for residual one-way pulsating currents with a direct component) are available in instantaneous, impulse-resistant and selective versions.

Moreover B class residual current circuit breakers in instantaneous and selective versions are available for the protection of electrical loads which can create fault currents with a direct component in case of earth leakage.

POWER LOSS PER DEVICE (W)							
Rated current In (A)							
Type AC, A, A[IR] and A[S]							
Poles	No. of modules	25	40	63	80	100	125
2	2	2,2	5,4	6,2	10,4	11	-
4	3	6	6	-	-	-	-
	4	3,5	6	12	16	18	25
Type B[IR] and B[S]							
2/4	4	1,2 (30mA) 0,65 (300mA)	3,2 (30mA) 1,65 (300mA)	4 (30mA) 3,2 (3/500mA)	6,4 (30mA) 4,8 (300mA)	-	-

Composition rules for the modular residual current circuit breakers

In order to obtain a residual current circuit breaker from a miniature circuit breaker, it is necessary to observe these rules:

- 1 - there is no residual current device that can be associated with the MTC circuit breakers. There is the MDC compact monobloc residual current circuit breaker with overcurrent protection.
- 2 - the BD add-on residual current device can only be associated with the MT circuit breakers.
- 3 - the BDHP add-on residual current device can only be associated with the MTHP circuit breakers.

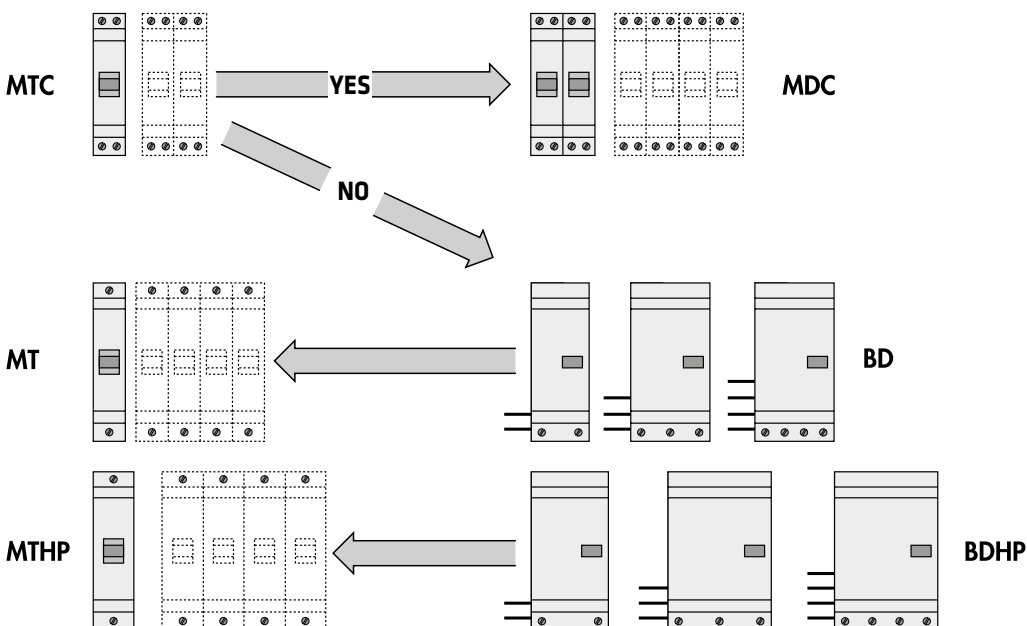

Tripping characteristics

Termo-magnetic

release

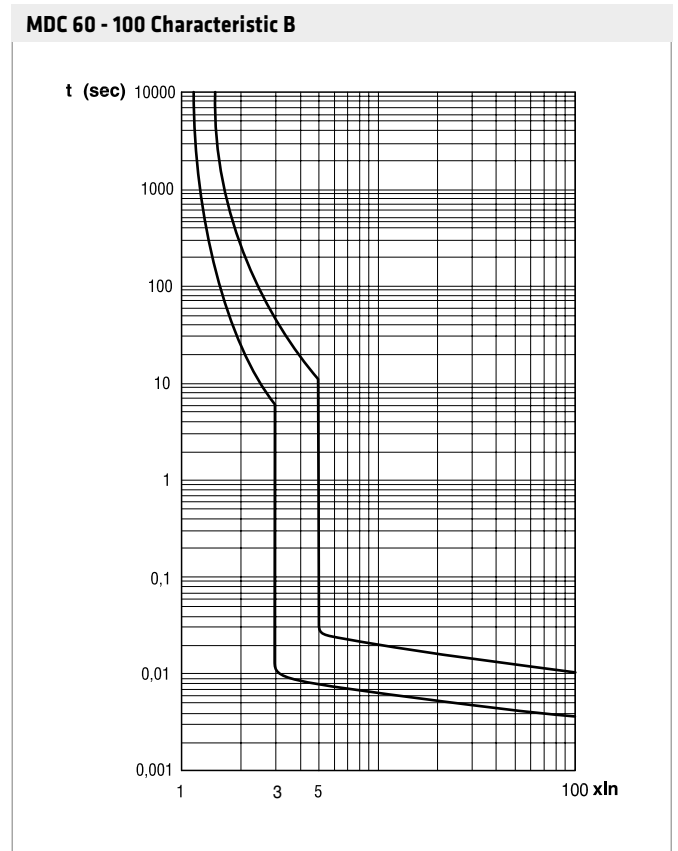
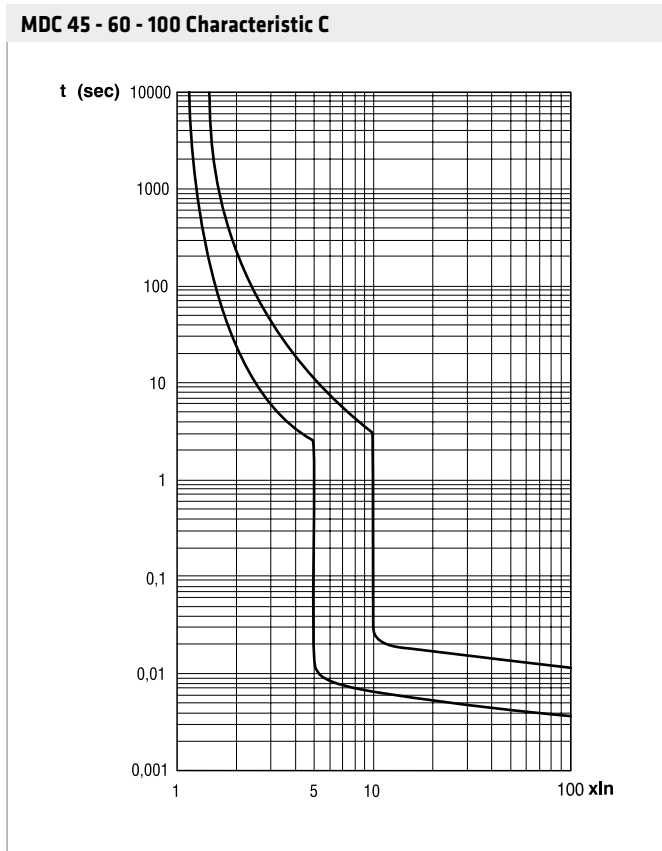

Peak current limitation characteristics

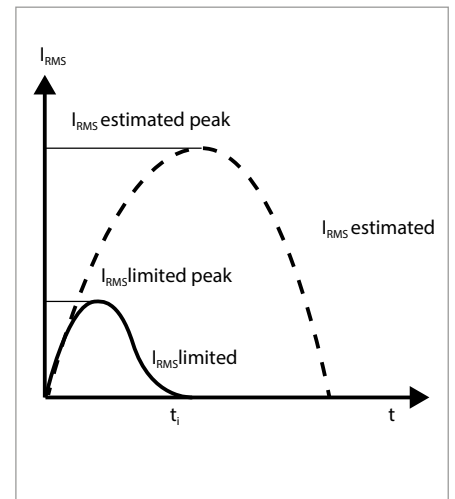
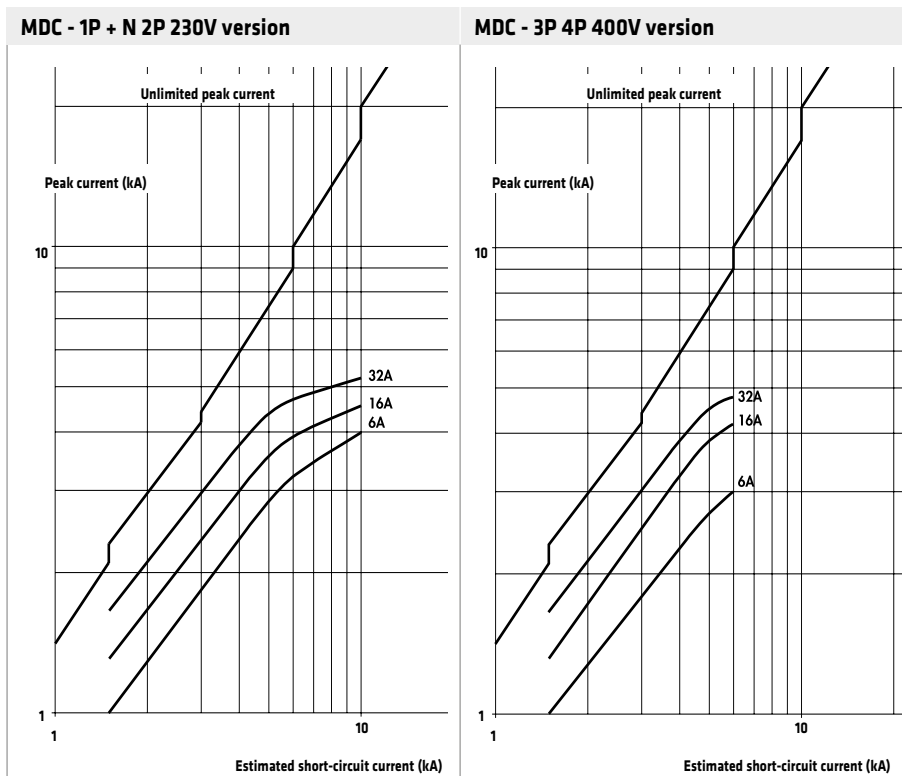

The following curves give the values of the peak current in relation to the estimated short-circuit current expressed in kA. Every curve refers to each rated current value of circuit breaker.

Specific let-through energy characteristics - MDC

MDC 45 - 1P+N, 2P - 230V versions

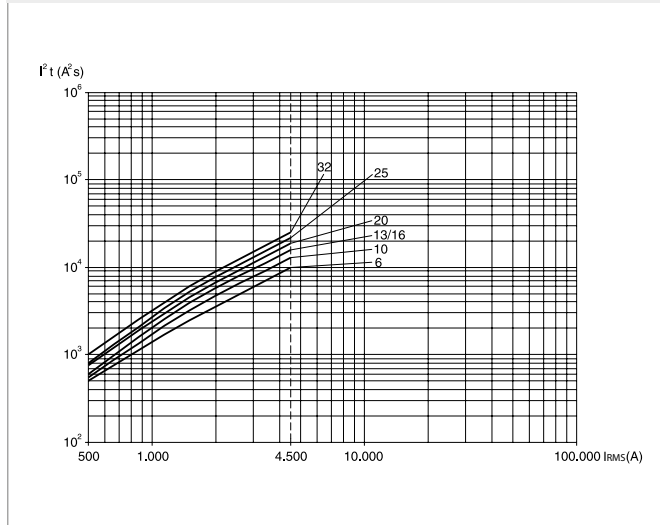

MDC 45 - 3P, 4P - 230/400V versions

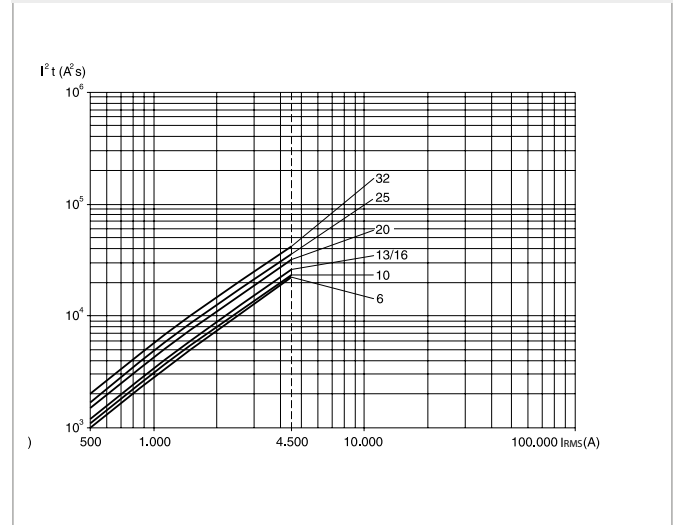

MDC 60 - 1P+N, 2P - 230V versions

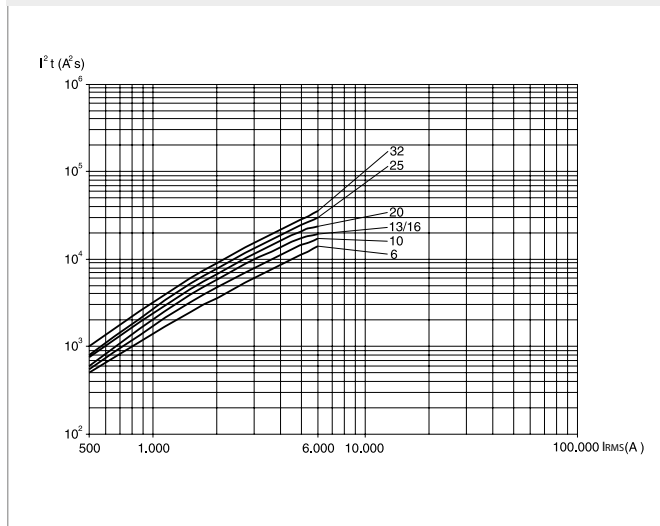

MDC 60 - 3P, 4P - 230/400V versions

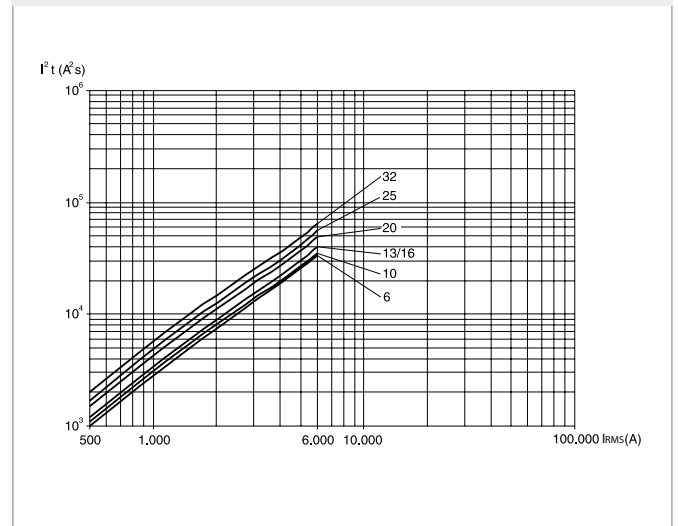

MDC 100 - 1P+N, 2P - 230V versions

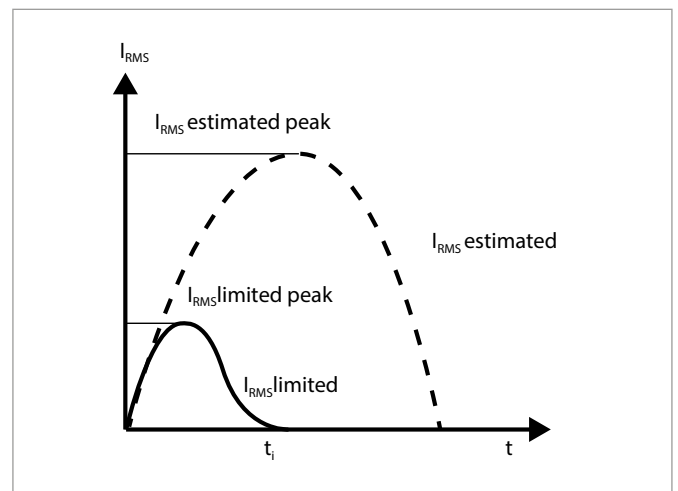
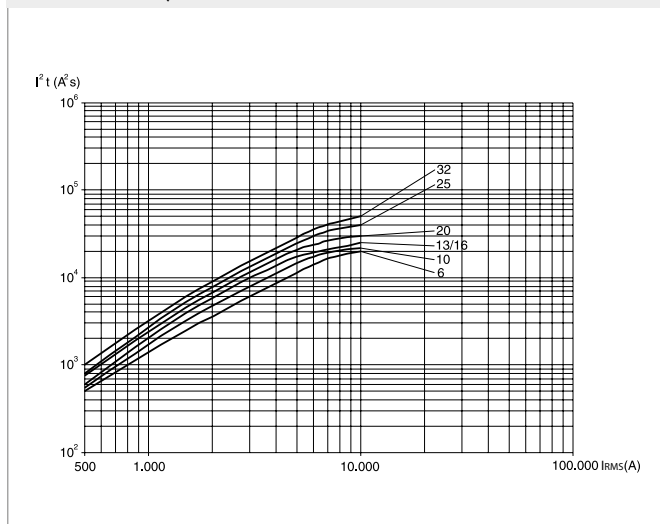

The curves above give the values of the specific let-through energy in relation to the short-circuit current expressed in A. Every curve refers to each rated current value of circuit breaker.

Residual current circuit breaker tripping characteristics

MDC - BD - BDHP - IDP

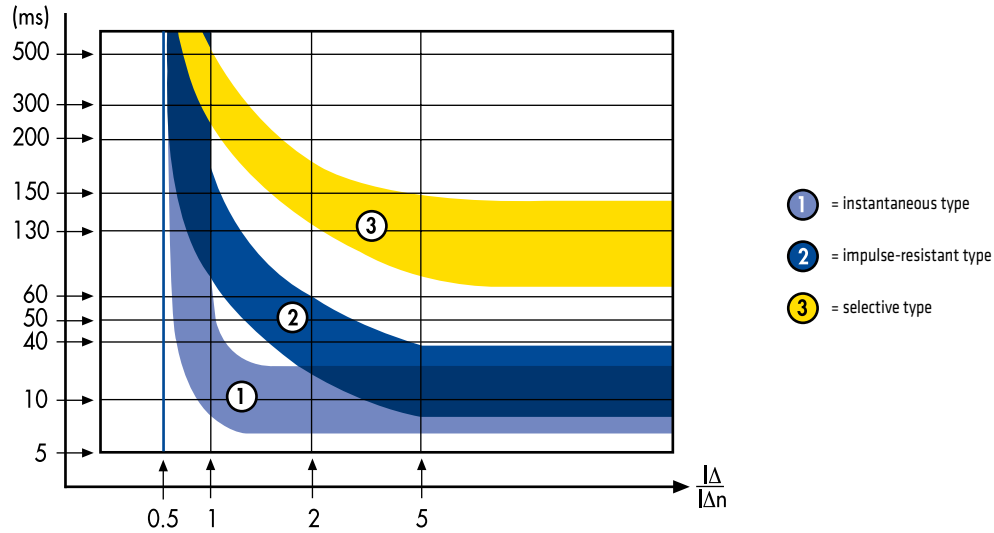

Dimension tables

MDC 45 - MDC 60 - MDC 100 RESIDUAL CURRENT CIRCUIT BREAKERS WITH OVERCURRENT PROTECTION

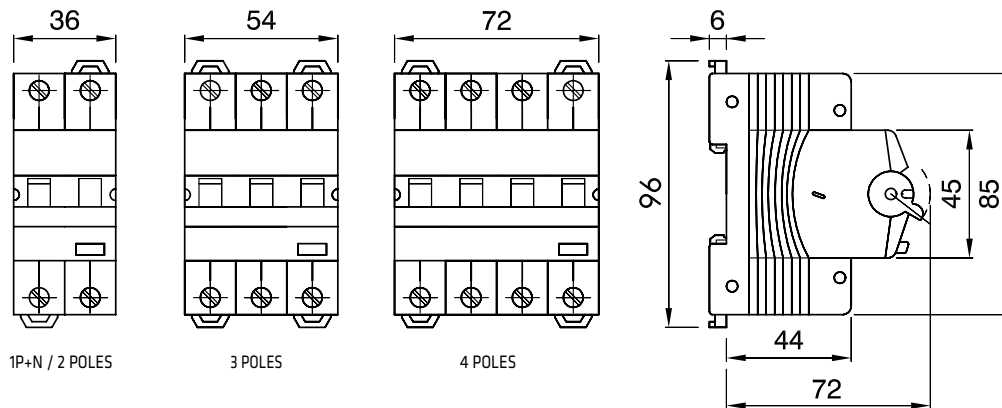

MODULAR DEVICES FOR RESIDUAL CURRENT PROTECTION

BD - ADD-ON RESIDUAL CURRENT DEVICES

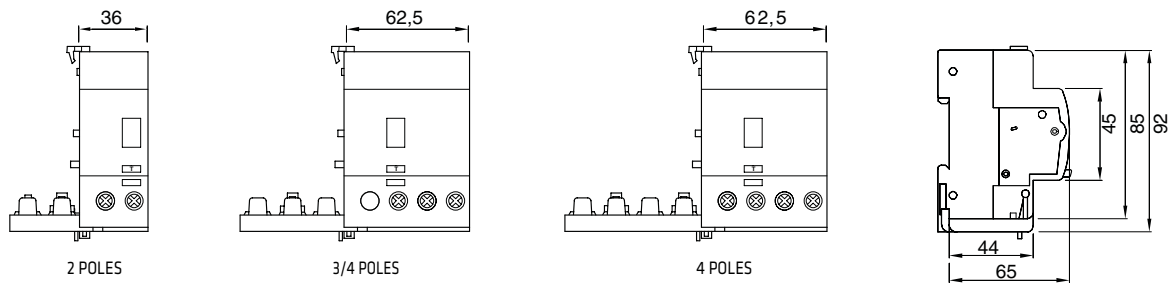

BDHP - ADD-ON RESIDUAL CURRENT DEVICES

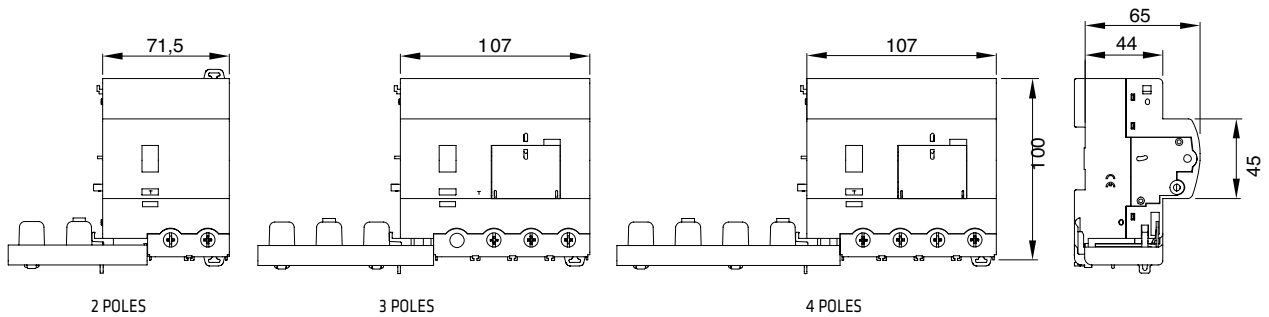

MODULAR DEVICES FOR RESIDUAL CURRENT PROTECTION

IDP - 2P AND 4P (4M) RESIDUAL CURRENT CIRCUIT BREAKERS

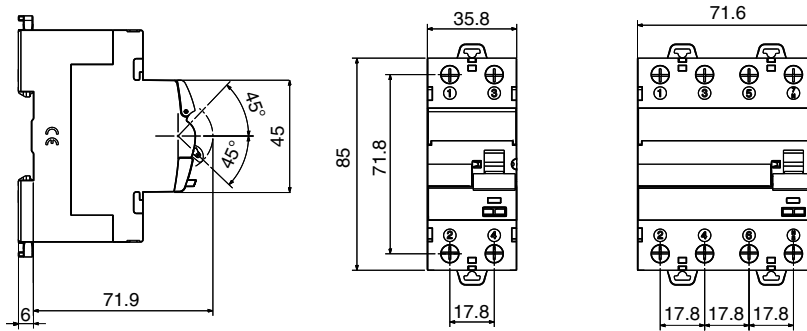

IDP - 4P (3M) RESIDUAL CURRENT CIRCUIT BREAKERS

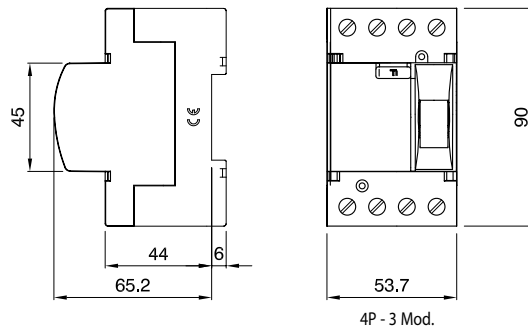

IDP - 125A RESIDUAL CURRENT CIRCUIT BREAKERS

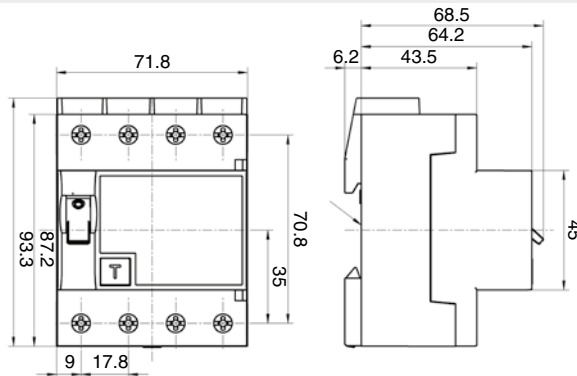

IDP - TYPE B RESIDUAL CURRENT CIRCUIT BREAKERS

