

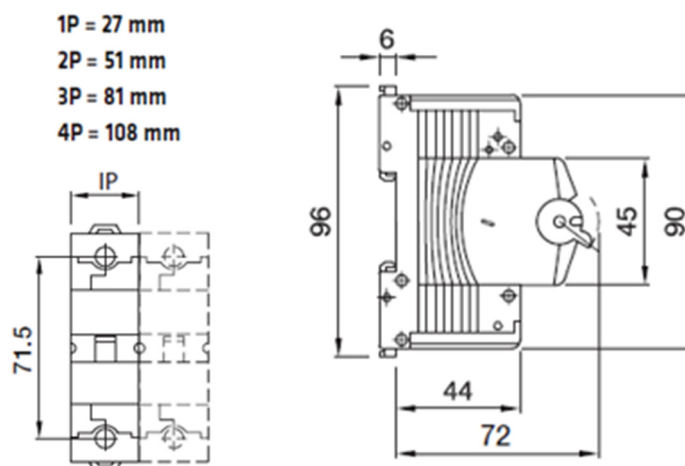

Høy effekt element automat MTHP160
Antall poler: 4
Antall moduler: 6
Merkestrøm: 100A
Karakteristikk: D
Merkespenning: 230-400V
Elnr: 1612729

Standard;	EN 60898, EN 60947-2	Frekvens (Hz)	50/60 Hz
Bryte kapasitet EN 60898 230V (Icn)	10000A	Bryte kapasitet EN 60898 400V (Icn)	10000A
Bryte kapasitet EN 60898 230V (Ics)	0,75 x Icn	Bryte kapasitet EN 60947-2 230V (Icu)	20 kA
Bryte kapasitet EN 60947-2 400V (Icu)	16kA	Bryte kapasitet EN 60947-2 (Ics)	50% Icu
Isolasjonsspenning	500 V	Nominell impulsstøtspenning	6 kV
Minimum drift spenning	12VAC/DC	Maks driftsspenning	440VAC/220VDC
Antall inn/utkoblinger elektrisk	10 000	Antall inn/utkoblinger mekanisk	20 000
Tverrsnitt enleder kabel	<=1x70 - <=2x25 - <=2x25+1x10 mm ²	Tverrsnitt fleksibel kabel	<=1x50(2) - <=2x25 - <=3x16 mm ²
Tiltrekningsmoment	3,5/3 (terminaler)	Driftstemperatur	-25 til +60° C
Lagringstemperatur	-40 til + 70° C	Electrocod	1411

Dimensjon



Standarder/godkjenninger

