

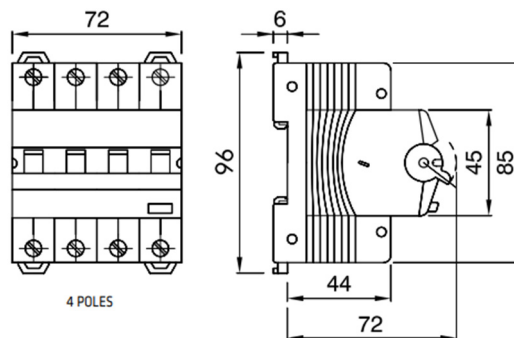

Jordfeilautomat MDC 60
Antall poler: 4
Antall moduler: 4
Merkestrøm: 20A
Karakteristikk: C
Type: A
Utløserstrøm: 30mA
Merkespenning: (EN/IEC 61009-1, 61009-2-1) 400/415 V
Elnr: 1612703

Standard;	IEC/EN 61009-1, IEC/EN 61009-2-1	Frekvens (Hz)	50/60 Hz
Bryte kapasitet EN 61009-1 230V (Icn)	6000A	Bryte kapasitet EN 61009-1 230V (Ics)	1 x Icn
Bryte kapasitet EN 60947-2 230V (Icu)	6 kA	Bryte kapasitet EN 60947-2 (Ics)	100% Icu
Isolasjonspenning	500 V	Støtstrøm sikker 8/20	250A
Nominell impulsstøtspenning	4 kV	Overspennings kategori	III
Antall inn/utkoblinger elektrisk	10 000	Antall inn/utkoblinger mekanisk	20 000
Tverrsnitt en leder kabel	<=1x35 - <=2x16 - <=1x16+2x10 mm ²	Tverrsnitt fleksibel kabel	<=1x35 - <=2x16 - <=1x16+2x10 mm ²
Tiltrekningsmoment	2Nm	Driftstemperatur	-25 til + 40° C
Lagringstemperatur	-40 til + 70° C	Testknapp test	Hver 6 mnd

Dimensjon



Standarder/godkjenninger



GEWISS S.p.A. Via A. Volta, 1
24069 Cenate Sotto - Bergamo - Italy
tel. +39 035 94 61 11 fax +39 035 94 69 09

Malthe Winje Automasjon AS
Haukeliveien 48,
1415 Oppegård
www.mwg.no

Data, measures, designs and pictures are shown only as informative purposes, and could be changed without previous notice