

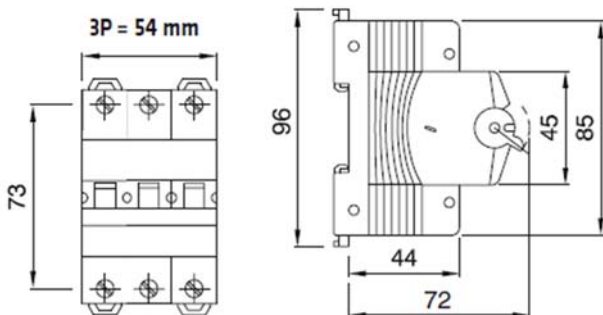

OV
Antall poler: 3
Antall moduler: 3
Merkestrøm: 50A
Merkespenning: 230/400V-240/415
Elnr: 1606491

Standard;	EN 60898, EN 60947-2	Frekvens (Hz)	50/60 Hz
Bryte kapasitet EN 60898 230V (Icn)	10000A	Bryte kapasitet EN 60898 400V (Icn)	10000A
Bryte kapasitet EN 60898 230V (Ics)	0,75 x Icn	Bryte kapasitet EN 60947-2 230V (Icu)	25 kA
Bryte kapasitet EN 60947-2 400V (Icu)	15kA	Bryte kapasitet EN 60947-2 (Ics)	50% Icu
Isolasjonsspenning	500 V	Nominell impulsstøtspenning	4 kV
Minimum drift spenning	12VAC/DC	Maks driftsspenning	440VAC/220VDC
Antall inn/utkoblinger elektrisk	10 000	Antall inn/utkoblinger mekanisk	20 000
Tverrsnitt enleder kabel	<=1x35 - <=2x16 - <=1x25+2x10 mm ²	Tverrsnitt fleksibel kabel	<=1x35 - <=2x16 - <=1x25+2x10 mm ²
Tiltrekningsmoment	2Nm	Driftstemperatur	-25 til +60° C
Lagringstemperatur	-40 til + 70° C		

Dimensjon



Selektivitet OV/Jordfeilautomater

Downstream	Upstream In[A]	OV Range Type ref. ASXXXXX				
		25	32	40	50	63
MDC100 Range Type ref. GW95XXX	6	1 kA	1 kA	1 kA	1 kA	1,5 kA
	10	1 kA	1 kA	1 kA	1 kA	1,5 kA
	16	1 kA	1 kA	1 kA	1 kA	1,5 kA
	20		1 kA	1 kA	1 kA	1,5 kA
	25				1 kA	1,5 kA
	32					1,5 kA

Standarder/godkjenninger

